



Transaxle

Remanufactured Commercial
Brake Calipers

OFF ROAD

Mobile Cranes | Forklifts | Towtugs



Catalogue 2024

<https://www.transaxlebrakecalipers.com>

V.2024



Transaxle

Remanufactured Commercial
Brake Calipers

Scan Here To Access Our Product Catalogues Online



OE NUMBERS USED FOR REFERENCE ONLY

Contents

03	Drum Brake Lining Rivets
04	Brake Shoes Brake Springs (Kessler, Wabco, Knott)
05	Compression/Pull Springs Spring Buckle Expander Units - Wabco
06	Repair Kits – Wabco Expander
07	Expander Units - Knott Repair Kits – Knott Expander
08	Wabco Brake Expander
09	Brake Drums
11	Air Chambers
13	Brake Manual Slack Adjuster Brake pads Perrot Expander
14	Caliper Assembly – Maxxus 22 Caliper
15	Repair Kits – Wabco Maxxus 22
16	Caliper Assembly – Pan 25 Caliper
17	Repair Kits – Wabco Pan 25
18	Caliper Assembly – Knorr SN7
19	Wheel Studs
20	Kirkstall Axles & Brake Parts – Offroad 15.5 x 8 Drum
21	Offroad NOx Sensors
25	Liebherr / Sennebogen Torque Arm
26	Offroad AdBlue Pump
27	Offroad Brake Pads
33	Parking Brakes

Telephone: 01922471300

Fax: 01922725072

Email: info@transaxle-ltd.co.uk

Address: Transaxle Ltd, Bescot House, Walstead Road West,
Walsall, West Midlands, WS5 4NY



Drum Brake Lining

Reference Number	Drum Diameter	WVA Number	Model (Equivalent to)	Number Of Holes/Rivets	Reference
TRX11595	500x120mm	WVA17237 PB15/1	KESSLER WABCO KNOTT	8 holes 10x18 rivet Old Version	
TRX11510	500x120mm	WVA17374 PB15/2	KESSLER WABCO KNOTT	10 holes 8x18 rivet New Version	
TRX11540	500x160mm	WVA19687 PB14/1	KESSLER WABCO KNOTT	8 holes 10x18 rivet Old Version	
TRX11550	500x160mm	WVA19042 PB14/2	KESSLER WABCO KNOTT	10 holes 8x18 rivet New Version	
TRX11580	500x180mm	WVA19690 PB13/1	KESSLER WABCO KNOTT	8 holes 10x18 rivet Old Version	
TRX11590	500x180mm	WVA19041 PB13/2	KESSLER WABCO KNOTT	14 holes 8x18 rivet New Version	
TRX11620	410x180mm	WVA19723 PB40/1	KESSLER WABCO KNOTT	8 holes 8x18 rivet Old Version	
TRX11630	410x180mm	WVA19113 PB40/2	KESSLER WABCO KNOTT	10 holes 10x18 rivet New Version	

Rivets

Reference Number	Version	Size	Reference
TRX11640	Old Version	10x18mm	
TRX11650	New Version	8x18mm	



Brake Shoes

Reference Number	Number Of Holes / Rivets / Shoe	Version	Model (Equivalent to)	Drum Diameter	Reference
TRX11520	16 Rivets	Simplex Old Version	WABCO	500x120mm	
TRX11530	20 Rivets	Simplex New Version	WABCO KNOTT	500x120mm	
TRX11560	16 Rivets	Simplex Old Version	WABCO	500x160mm	
TRX11570	20 Rivets	Simplex New Version	WABCO KNOTT	500x160mm	
TRX11600	16 Rivets	Duplex Old Version	WABCO	500x180mm	
TRX11610	28 Rivets	Duplex New Version	WABCO KNOTT	500x180mm	
TRX11997	16 Rivets	Simplex Old Version	WABCO	410x180mm	
TRX11990	20 Rivets	Simplex New Version	WABCO KNOTT	410x180mm	
TRX11995	16 Rivets	Duplex Old Version	WABCO	410x180mm	
TRX11630	20 Rivets	Duplex New Version	WABCO KNOTT	410x180mm	

Brake Springs

Reference Number	Model (Equivalent to)	Brake Shoe Size	Reference
TRX11760	WABCO	180mm	 Overall length: 240mm
TRX11760	KNOTT	180mm	
TRX11770	KESSLER	180mm	
TRX11780	KESSLER	120mm & 160mm	



Compression Spring

	Reference Number	Drum Diameter	Model (Equivalent to)	Reference
	TRX11790	180mm 13302008	WABCO	



Pull Springs

	Reference Number	Original Equipment	Pull Spring	Model (Equivalent to)	Reference
	TRX11581	13301042	95mm	KESSLER	
	TRX11582	13301134	275mm	KESSLER	
	TRX11583	13301043	----	KESSLER	

Spring buckle

	Reference Number	Original Equipment	Model (Equivalent to)	Reference
	TRX11584	Knott: 46176 13626005	KESSLER / KNOTT	

Expander Units – Wabco

	Reference Number	Version	Brake Shoe Size	Model (Equivalent to)	Reference
	New: TRX11965 Rebuilt: TRX085	Simplex Expander 12739085VT	500x120mm 500x160mm 410x180mm	WABCO	
	New: TRX11975 Rebuilt: TRX086	Duplex Expander 12739086VT	500x180mm	WABCO	



Repair Kits – Wabco Expander

Graph Ref	Reference Number	Version	Original equipment	Model (Equivalent to)	Reference
SE - 2 DE - 2	TRX11745	Both Expanders	N/A	WABCO	
DE - 3 / 7 / 8	TRX11753	Duplex Expander	12999519VT	WABCO	
	TRX11740	Duplex Expander	N/A	WABCO	
SE - 3 / 5	TRX11751	Simplex Expander	12999518VT	WABCO	
	TRX11750	Simplex Expander	12999292VT	WABCO	
SE - 2 / 4 DE - 2 / 4	TRX11765	Both Expanders (End Kit)	N/A	WABCO	
	TRX110051E	Duplex	N/A	WABCO	
	TRX11005E	Simplex	N/A	WABCO	

Simplex Expander

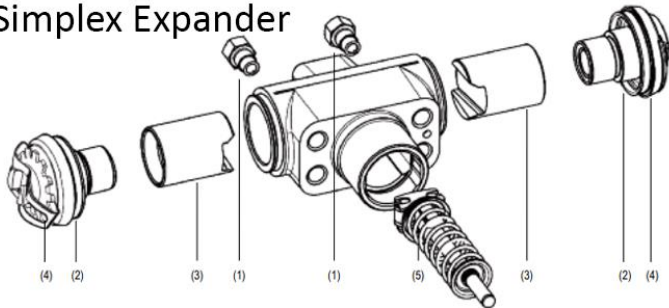

- (1) Hexagon screw
- (2) Bellow seal
- (3) Plunger
- (4) Adjustment cpl. (incl. bellow)
- (5) Actuation wedge cpl.

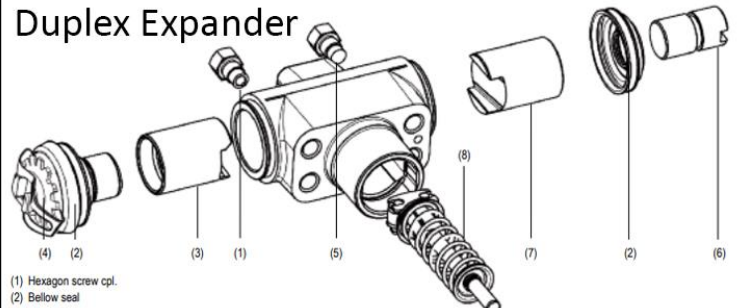

Duplex Expander







- (1) Hexagon screw cpl.
- (2) Bellow seal
- (3) Plunger
- (4) Adjuster cpl. (incl. bellow)
- (5) Hexagon screw M14
- (6) Bolt 28x40
- (7) Plunger
- (8) Actuation wedge cpl.



Expander Units - Knott

Reference Number	Version	Brake Shoe Size	Model (Equivalent to)	Reference
New: TRX11720 Rebuilt: TRX502	Simplex Expander	500x120mm 500x160mm 410x180mm	KNOTT	
New: TRX11730 Rebuilt: TRX503	Duplex Expander	500x180mm	KNOTT	

Repair Kits – Knott Expander

Reference Number	Version	Original equipment	Model (Equivalent to)	Reference
SE - 2 DE - 2	Both Expanders	N/A	KNOTT	
SE - 2 / 4 DE - 2 / 4	Both Expanders Expander End Assembly		KNOTT	
SE - 5 DE - 8	Both Expanders Expander Wedge		KNOTT	
TRX19188	Duplex	N/A	KNOTT	
TRX11865	Simplex	N/A	KNOTT	

Simplex Expander

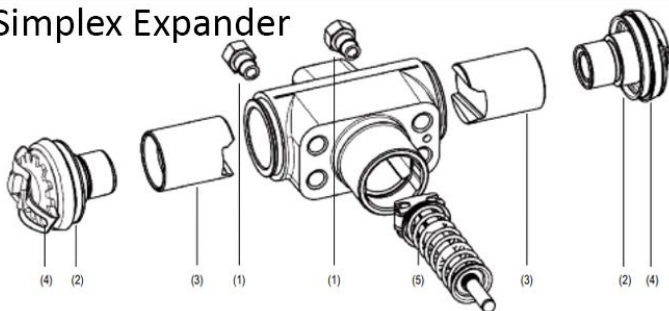

- (1) Hexagon screw
- (2) Bellow seal
- (3) Plunger
- (4) Adjustment cpl. (incl. bellow)
- (5) Actuation wedge cpl.

Duplex Expander

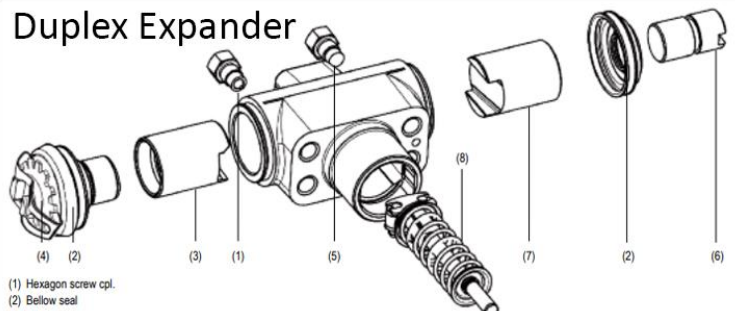

- (1) Hexagon screw cpl.
- (2) Bellow seal
- (3) Plunger
- (4) Adjuster cpl. (incl. bellow)
- (5) Hexagon screw M14
- (6) Bolt 28x40
- (7) Plunger
- (8) Actuation wedge cpl.



Transaxle

Remanufactured Commercial
Brake Calipers

OE NUMBERS USED FOR REFERENCE ONLY

Scan Here To Access Our Product Catalogues Online



Wabco Brake Expander

Reference Number	Version	Wabco Reference	Reference
TRX048		12739048VT	
TRX070	Imperial Duplex	12739070VT	
TRX071	Imperial Duplex	12739071VT	



Brake Drums

Reference Number	Model (Equivalent to)	Overall Height	Drum Diameter (+ Internal)	Braking Surface	Stud Holes	Pitch Circle Diameter of Stud Holes	Reference
TRX11810	KESSLER 8134571	192mm	500 mm (295 mm)	165mm	10x23mm	335mm	
TRX11820	KESSLER 8129781	263mm	500 mm (300 mm)	185mm	10x23mm	335mm	
TRX11830	KESSLER 8144551	241.5mm	500 mm (385 mm)	195mm	12x23mm	425mm	
TRX11840	KESSLER 8148661	223mm	500 mm (385 mm)	176mm	12x23mm	425mm	
TRX11800	KESSLER 7136501	243mm	500 mm (300 mm)	189mm	10x23mm	335mm	
TRX11850	KESSLER 8128981	230mm	500 mm (300 mm)	145mm	10x23mm	335mm	
TRX11860	KESSLER 8112561	249mm	500 mm (300 mm)	165mm	10x23mm	335mm	
TRX11870	KESSLER 8130101	241mm	410 mm (300 mm)	186mm	10x23mm	335mm	
TRX11880	KESSLER 8125401 816233	241mm	410 mm (300 mm)	191mm	10x23mm	335mm	









Brake Drums

Reference Number	Model (Equivalent to)	Drum Diameter (+ Internal)	Braking Surface	Stud Holes	Pitch Circle Diameter of Stud Holes	Overall Height	Reference
TRX11890	KESSLER 8119801	500mm (385mm)	180mm	10x22.5mm	425mm	210mm	
TRX11900 TRX11910	KESSLER 8144411 814523	500mm (385mm)	165mm	10x23mm	425mm	217mm	
TRX11920	KESSLER 8119591	500mm (385mm)	185mm	12x23mm	335mm	230mm	
TRX11930	KESSLER 4710870	500mm (370mm)	183mm	12x23mm	425mm	241mm	
TRX11940	KESSLER 4710981	500mm (295mm)	189mm	10x23mm	335mm	243mm	
TRX11950	KESSLER 8150111	500mm (300mm)	165mm	10x23mm	335mm	266.5mm	
TRX11960	KESSLER 8122871	500mm (Hub cover dome)	164mm	10x23mm	335mm	192mm	
TRX11970	KESSLER 8145241	500mm (385mm)	182mm	12x23mm	425mm	248mm	



Air Chambers



Reference Number	X Reference	Version	Model (Equivalent to)	Reference
TRX31000	<u>4253331000</u> 1505952 99708410733 5026533 / 00051912	<u>20/20</u> Mounting = M45x1.5 O/L = 464mm Tube L = 194mm	Tri stop Wedge Tube Mount Spring Brake Actuator	
TRX10010	<u>4253310010</u> 72606 / 5029370 502937014 25610340	<u>24/24</u> Mounting = M45x1.5 O/L = 528mm Tube L = 262.5mm	Tri stop Wedge Tube Mount Spring Brake Actuator	
TRX10000	<u>4253310000</u> 1505951 99708458790 8458790 / 25641340 5029692 0005680094	<u>24/24</u> Mounting = M45x1.5 O/L = 427mm Tube L = 161.5mm	Tri stop Wedge Tube Mount Spring Brake Actuator	
TRX10030	<u>4253310030</u> 32372040 / 320049 5029502 99708474816 502950208 R2203084H	<u>24/24</u> Mounting = M45x1.5 O/L = 480mm Tube L = 214.5mm	Tri stop Wedge Tube Mount Spring Brake Actuator	
TRX69000	<u>4253106900</u> T22034236	<u>24/24 Long</u> Mounting = x O/L = mm Tube L = mm	Tri stop Wedge Tube Mount Spring Brake Actuator	
TRX846N00	<u>K136846N00</u> T22038042	<u>24/24 Short</u> Mounting = x O/L = mm Tube L = mm	Tri stop Wedge Tube Mount Spring Brake Actuator	
TRX32120	<u>4253332120</u> 1518657 99707723401 11014309	<u>20/24</u> Mounting = M45x1.5 O/L = 465mm Tube L = 192mm	Tri stop Wedge Tube Mount Spring Brake Actuator	
TRX332000	<u>4253332000</u> 1518656 99708410741 32404940	<u>20/24</u> Mounting = M45x1.5 O/L = 401mm Tube L = 128mm	Tri stop Wedge Tube Mount Spring Brake Actuator	





<p>TRX45000</p>	<p><u>4230450010</u> 1505934 / 1619264 16192648410750 8410750 / 23400840 5029843</p>	<p><u>Type 20 Single</u> Mounting = M45x1.5 Tube L = 217mm</p>	<p>Tri stop Wedge Tube Mount Spring Brake Actuator</p>	
<p>TRX40300</p>	<p><u>4230740300</u> T22038027</p>	<p><u>Type 20</u> Mounting = M45x1.5 Tube L = 277mm</p>	<p>Tri stop Wedge Tube Mount Spring Brake Actuator</p>	
<p>TRX60010</p>	<p><u>4230460010</u> 5026273 / 502627308 0005680110 36511016001 070210100 11013190</p>	<p><u>Type 24 Single</u> Mounting = M45x1.5 Tube L = 276.5mm</p>	<p>Tri stop Wedge Tube Mount Spring Brake Actuator</p>	
<p>TRX300000</p>	<p><u>4253300000</u> 1526614 99708458760 1932656</p>	<p><u>Type 16/16</u> Mounting = M45x1.5 O/L = 426mm Tube L = 162mm</p>	<p>Tri Stop Wedge Brake Spring Brake Actuator</p>	
<p>TRX70640</p>	<p><u>4253270640</u> 1518655 / T22036972 04778468 42030594 42071450 637207100</p>	<p><u>Type 12/12</u> Mounting = 1 3/4" O/L = 351mm Tube L = mm</p>	<p>Tri Stop Wedge Brake Spring Brake Actuator</p>	
<p>TRX301010</p>	<p><u>4253301010</u> 1505950 8458789 38762040 5029125 96920100</p>	<p><u>Type 18/24</u> Mounting = M45x1.5 O/L = 412mm Tube L = mm</p>	<p>Tri Stop Wedge Brake Spring Brake Actuator</p>	
<p>TRX032N00</p>	<p><u>K137032N00</u> T22038040</p>	<p><u>20/30 Short</u> Mounting = x O/L = mm Tube L = mm</p>	<p>Tri Stop Wedge Brake Spring Brake Actuator</p>	
<p>TRX303601</p>	<p><u>1498303</u> 983031498303 HY1498303 T-3036-01</p>	<p><u>30/36</u> Mounting = x O/L = mm Tube L = mm</p>	<p>Tri Stop Wedge Brake Spring Brake Actuator</p>	
<p>TRX11754</p>	<p><u>13551045</u> E75503594 9970840380 502219608 N1011013186 6254210072</p>	<p>Mounting = M45x1.5 Size = 54 x 54 x 35</p>	<p>Securing Nut</p>	

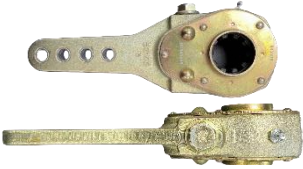



Brake Manual Slack Adjuster

Reference Number	Version	Model (Equivalent to)	Reference
TRX101020450	5/6/7/8 Inches	10 Spline PL30 Straight 140 / 150 / 160 mm holes	
TRX279946	6+7 Inches	10 Spline	

Brake Pads

Reference Number	Version	Model (Equivalent to)	Reference
TRX11980	Without Wire	WABCO	
TRX11985	With Wire	WABCO	

Wabco Perrot Adjuster / Expander

Reference Number	X Ref & Descriptions	Reference
TRX178	12603042VT / 12603084VT / 12603178VT 898240H1 / 803601765 / 6629930 / 1518442 1518434 / 802701665 / 2944065M1 / 5021170482 1518436 / 3071873M91	
TRX12322	Cap Head Expander Bolt M12 X 1.5 X 25inch	



Caliper Assembly – MAXXUS 22 Caliper

	Reference Number	X Reference	Model (Equivalent to)	Information	Reference
2010 → To Date Fits: Demag / Kessler Liebherr / Spiering Terex	TRX7720	6403220790 640322079	WABCO	<u>MAXXUS 22</u> +12 Degree No <u>Wear</u> <u>Sensor</u> Off Centre BonL, SonL	
2010 → To Date Fits: Demag / Kessler Liebherr / Spiering Terex	TRX7725	6403220800 640322078	WABCO	<u>MAXXUS 22</u> +12 Degree No <u>Wear</u> <u>Sensor</u> Off Centre BonR, SonR	
	TRX1028	KE1028	WABCO OD = 525	<u>MAXXUS 22</u> Brake Disc	
	TRX1029	KE1029	WABCO OD = 434	<u>MAXXUS 22</u> Brake Disc	



Transaxle





Remanufactured Commercial
Brake Calipers

OE NUMBERS USED FOR REFERENCE ONLY

Scan Here To Access Our Product Catalogues Online



Repair Kits – Wabco MAXX 22

Reference Number	X Reference	Model (Equivalent to)	Information	Reference
TRX229212	6403229212	WABCO	<u>MAXX 22</u> Wear Indicator	
TRX4012	6403229272	WABCO	<u>MAXX22</u> Repair Kit / Gear Wheel Adjuster Kit 180 x 85 x 45	
<u>Left Hand</u> TRX4062 <u>Right Hand</u> TRX4072	6403229312	WABCO	<u>MAX22</u> Pressure Plate 209 x 169 x 93	
TRX1000112	3001000112	WABCO	<u>MAXX 22</u> Adjuster Change 210 x 75 x 70	







Caliper Assembly – PAN 25 Caliper

PAN 25 CALIPER



6402500040
6402500050

	Reference Number	X Reference	Model (Equivalent to)	Information	Reference
2010 → To date Fits: Demag / Kessler Liebherr / Spiering Terex	TRX50004 REMAN: TRX50004R	640250004	WABCO	<u>PAN 25</u> O/S Right Hand	
	A - BRAKE DISC: TRX40641	7240641 6622500010	WABCO	<u>PAN 25</u>	
2010 → To date Fits: Demag / Kessler Liebherr / Spiering Terex	TRX50005 REMAN: TRX50005R	640250005	WABCO	<u>PAN 25</u> O/S Left Hand	
	A - BRAKE DISC: TRX40641	7240641 6622500010	WABCO	<u>PAN 25</u>	



Repair Kits – Wabco Pan 25

Reference Number	X Reference	Model (Equivalent to)	Information	Reference
TRX11420	12999738	WABCO <u>PAN 25</u>	Slider Kit	
TRX13247	6401759202	WABCO <u>PAN 25</u>	Tappet Kit 182 x 88 x 50	
TRX99797	12999797	WABCO <u>PAN 25</u>	Wear Indicator Kit 187 x 98 x 81	
TRX509212	6402509212 <u>Liebherr</u> 9640 258 08	WABCO <u>PAN 25</u>	Pad Set 170 x 130 x 280	
TRX59262	6402259262	WABCO <u>PAN 25</u>	Push Plate 208 x 167 x 93	
TRX509202	6402509202	WABCO <u>PAN 25</u>	Disc Brake 540 x 160 x 550	



Caliper Assembly – Knorr SN7

SN7329 - TRX7329/7330 - SN7330

Brake Disc	81.8667.3 – TRX86673
1575 – Lining Kit	II180220062 - TRX220062
1571 – Slider Kit	K000472 – TRX11457
Tappet Kit	K010603 – TRX11351
1570 – Carrier	K011507 – TRX011507
1576/157 – Wear Indicator	K000683 – TRX000683

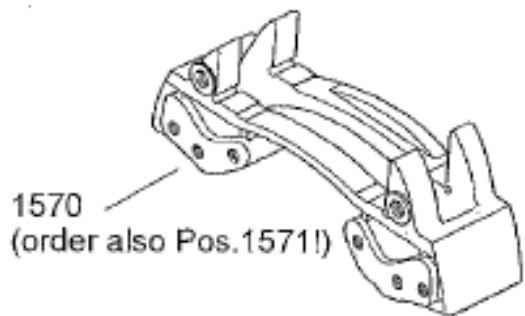
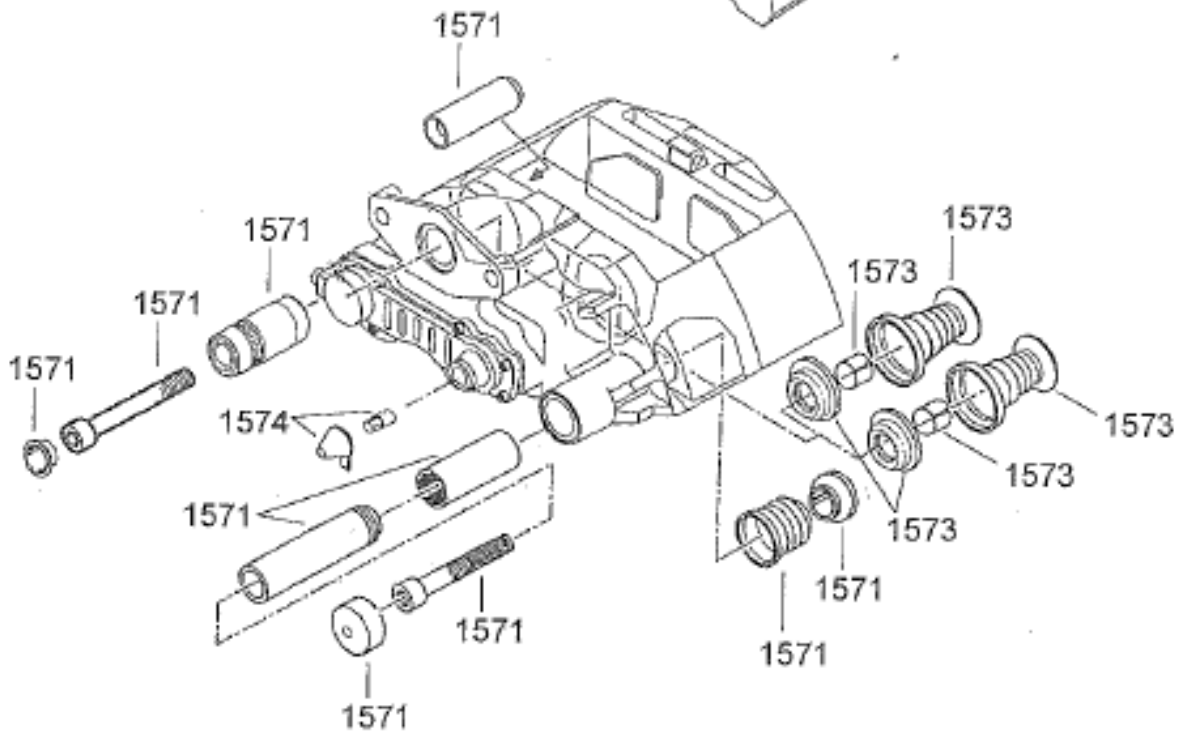
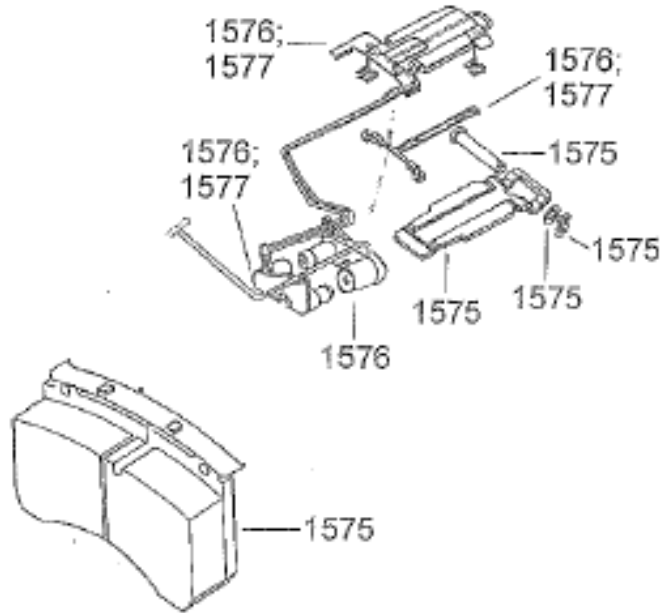



Wheel Studs

	Reference Number	Information / Length from the under head	Kessler No.
	TRX-S1	162mm Long	109-2747-P1
	TRX-S2	147mm Long	109-2747-P2
	TRX-S3	127mm Long	109-2747-P3
	TRX-S4	110mm Long	109-2747-P4
	TRX-S6	95mm Long	109-2747-P6
	TRX-S7	88mm Long	109-2747-P7
	TRX-S9	82mm Long	109-2747-P9
	TRX-S12	75mm Long	109-2747-P12
	TRX-S13	62mm Long	109-2747-P13
	TRX-S14	TBA	109-2747-P14
	TRX-S18	TBA	109-2747-P18
	TRX11665	M22 Flanged Nut	74361N22F





Transaxle

Remanufactured Commercial
Brake Calipers

Scan Here To Access Our Product Catalogues Online

OE NUMBERS USED FOR REFERENCE ONLY



Kirkstall Axles & Brake parts – Offroad 15.5x8 Drum



Reference Number	Part Name	X Reference
TRXR8069/65P	Brake Spider 8 Hole	R8069 / 65P
TRXR3217/65P	Brake Spider 16 Hole	R3217 / 65P
TRXR8069/60	Brake Shoe	R8069 / 60
TRXF4308/117G	Brake Lining	F4308 /117G
TRX7758/99	Brake Shoe Pivot Pin	7758 / 99
TRXSL795/7	Brake Shoe Pivot Pin Set Screw	SL795 / 7
TRX7758/40	Brake Shoe Pivot Pin Lock Screw	7758 / 40
TRX6954/165	Brake Shoe Return Spring	6954 / 165
TRX6954/82	Brake Shoe Anchor Pin	6954 / 82
TRXSL795/68	Brake Spider Bolt	SL795 / 68
TRX7321/84	Brake Dust Cover	7321 / 84
TRX6954/54	Brake CAM Bush	6954 /54
TRXR3185/187	Brake CAM Oil Seal	R3185 / 187
TRXSL1000/13	Brake CAM Lubricator	SL1000 / 13
TRX7758/54	Brake Shoe Pivot Pin Bush	7758 / 54
TRX6954/135	Brake Shoe Roller	6954 / 135
TRX7600/134	Brake Shoe Roller Pin	7600 / 134



Offroad NoX Sensors

Reference Number	Information	Image Reference
TRX415128	<p>NoX Sensor <u>Perkins</u> 6 Pins</p> <p>Length (mm): - Cable Length (mm): 889 Width (mm): - Height (mm): - Bore Ø (mm): - Voltage (V): 24 Thread Size: M20 Thread Pitch: 1.5 Connectors: 6 Perkins: T421092 / 441-5128 / 4415128 / 5WK96726A</p>	
TRX415127	<p>NoX Sensor <u>Perkins</u> 6 Pins</p> <p>Length (mm): - Cable Length (mm): 886 Width (mm): - Height (mm): - Bore Ø (mm): - Voltage (V): 24 Thread Size: M20 Thread Pitch: 1.5 Connectors: 6 Perkins: 441-5127 / 4415127 / A2C10474600125B</p>	
TRX599172	<p>NoX Sensor Fitted for <u>Caterpillar</u></p> <p>Cable Length (mm): - Width (mm): - Height (mm): - Bore Ø (mm): - Voltage (V): 24 Thread Size: - Thread Pitch: - Connectors: - CAT: 359-9172 / 3599172 / 5WK96726</p>	
TRX599171	<p>NoX Sensor Fitted for <u>Caterpillar</u></p> <p>Cable Length (mm): - Width (mm): - Height (mm): - Bore Ø (mm): - Voltage (V): 24 Thread Size: - Thread Pitch: - Connectors: - CAT: 359-9171 / 3599171 / 5WK96725A</p>	



	TRX552183	<p>NoX Sensor Fitted for <u>John Deere Tractor</u></p> <p>Length (mm): - Cable Length (mm): - Width (mm): - Height (mm): - Bore Ø (mm): - Voltage (V): 24 Thread Size: - Thread Pitch: - Connectors: - John Deere: RE552183 / <u>5WK96774</u></p>	
	TRX575062	<p>NoX Sensor Fitted for <u>John Deere</u></p> <p>Cable Length (mm): - Width (mm): - Height (mm): - Bore Ø (mm): - Voltage (V): 24 Thread Size: - Thread Pitch: - Connectors: - John Deere: RE575062 / SNS352 / <u>5WK97352</u></p>	
	TRX99001	<p>NOx Sensor Fitted for <u>Liebherr</u></p> <p>Length (mm): - Cable Length (mm): 890 Width (mm): - Height (mm): - Bore Ø (mm): - Voltage (V): 24 Thread Size: - Thread Pitch: - Connectors: - Liebherr: <u>SNS0910</u> / 12412141</p>	
	TRX99002	<p>NOx Sensor Fitted for <u>Liebherr</u></p> <p>Length (mm): - Cable Length (mm): - Width (mm): - Height (mm): - Bore Ø (mm): - Voltage (V): 24 Thread Size: - Thread Pitch: - Connectors: - Liebherr: <u>5WK96716</u> / 11008787</p>	



	TRX535536	<p>NOx Sensor Fitted for <u>JCB</u></p> <p>Length (mm): - Cable Length (mm): - Width (mm): - Height (mm): - Bore Ø (mm): - Voltage (V): - Thread Size: - Thread Pitch: - Connectors: - JCB: 0281006535 / 0281006536</p>	
	TRX537538	<p>NOx Sensor Fitted for <u>JCB</u></p> <p>Length (mm): - Cable Length (mm): - Width (mm): - Height (mm): - Bore Ø (mm): - Voltage (V): - Thread Size: - Thread Pitch: - Connectors: - JCB: 0281006537 / 0281006538</p>	
	TRX533534	<p>NOx Sensor Fitted for <u>JCB</u></p> <p>Length (mm): - Cable Length (mm): - Width (mm): - Height (mm): - Bore Ø (mm): - Voltage (V): - Thread Size: - Thread Pitch: - Connectors: - JCB: 0281006533 / 0281006534</p>	
	TRX505506	<p>NOx Sensor Fitted for <u>JCB</u></p> <p>Length (mm): - Cable Length (mm): - Width (mm): - Height (mm): - Bore Ø (mm): - Voltage (V): - Thread Size: - Thread Pitch: - Connectors: - JCB: 0281006505 / 0281006506</p>	



	TRX466642	<p>NOx Sensor Fitted for <u>DEUTZ</u></p> <p>Length (mm): - Cable Length (mm): - Width (mm): - Height (mm): - Bore Ø (mm): - Voltage (V): - Thread Size: - Thread Pitch: - Connectors: - DEUTZ: 5WK97420 / 04466641 / 04466642 04466643 / 22417668</p>	
	TRX96711C	<p>NOx Sensor Fitted for <u>Iveco</u></p> <p>Length (mm): - Cable Length (mm): - Width (mm): - Height (mm): - Bore Ø (mm): - Voltage (V): - Thread Size: - Thread Pitch: - Connectors: - Iveco: 5WK96711C / 84292579 / 84414466</p>	



Liebherr Torque Arm

Reference Number	Information	Image Reference
TRX43508	<p><u>Liebherr Torque Arm Assembly</u> Length1 = 710mm / Thickness = 30mm</p> <p>Liebherr: <u>521143508</u> / 521135408 / 29910732 2365401 / 114373 / 066360002730</p>	
TRX94709	<p><u>Liebherr Torque Arm Assembly LH</u> Length1 = 210mm / Thickness = 30mm</p> <p>Liebherr: <u>2994709</u></p>	
TRX96414	<p><u>Liebherr Torque Arm Assembly RH</u> Length1 = 210mm / Thickness = 30mm</p> <p>Liebherr: <u>2996414</u></p>	

Sennebogen Torque Arm

Reference Number	Information	Image Reference
TRX048596	<p><u>Sennebogen Model 6200</u></p> <p>Misc: <u>048596</u></p>	



Offroad Adblue Pump

Reference Number	Information	Image Reference
TRX2165	<p>Bosch <u>Caterpillar</u> Pump Dosing Module</p> <p>Bosch: 0444042165 / 0444042166 / 0444042060 0444042059</p> <p>Misc: 20R4049 / 20R9602 / 398-4746 / 3984746 591-2385 / 5912385 / T414988 098644D228</p>	
TRX1246	<p>Bosch <u>Caterpillar</u> 24V Urea AdBlue Pump</p> <p>Weichai: 612604130574</p> <p>Bosch: 0444110011 / 0444110012 / 0444110014</p> <p>Iveco: 5801863567</p> <p>Perkins: 450-8101</p>	



Offroad Brake Pads

Cross Reference	Part No & Application	Information	Image Reference
WVA20494, 8455000902, 8455200321, 8455200355, 8455454894, 9938109, 7701200247, 7701201315, 7701201470, 7701201716	<u>73329</u> Dacia, Fiat, Renault	Set Pcs: 4 Width (mm): 108.6 Height (mm): 49.3 Thickness (mm): 14	
4E9701, 8R0807, 7K4941, 3V5465, 840472, 6630293, 6643244, 11992695, 11991354	<u>73367</u> Caterpillar, Clark, Volvo	PAD102 Set Pcs: 1 Width (mm): 178 Height (mm): 73.5 Thickness (mm): 22.5	
840611, 11992696, 9051433, 15/300114, 05122-14006, 7K5057, 8R0821, D77519, 9065346, 840611, 947932, 4E9702	<u>73368</u> Case, Caterpillar, Furukawa, JCB, Kawasaki, Komatsu, Terex, Volvo	PAD104 Set Pcs: 1 Width (mm): 278 Height (mm): 86 Thickness (mm): 22	
11992694, 11709042, 11994540, 217810, 223906, 333/S9336, 6213353, 998/10399, 008479003, T50762, 6630406, N7961	<u>73382</u> Case, Caterpillar, Euclid, JCB, O and K, Terex, Thwaites, Volvo	Set Pcs: 1 Width (mm): 277 Height (mm): 104 Thickness (mm): 24	
5054285, 566-32-53210, 556- 32-53221, 566-32-53211, 566- 32-53220, 5054286, 9C0566, 9C0567, 9059263, 5054286	<u>73383</u> Case, Caterpillar, Euclid, Komatsu, Moxy, Terex, Volvo	Set Pcs: 1 Width (mm): 397 Height (mm): 115.4 Thickness (mm): 28	
9640093, 9640351, SW454197, 841241, 841367, 841419, AK1532, VE2186, 12969143, 4963502	<u>73384</u> Aveling Barford, Clark, Dresser, Euclid, Volvo	Set Pcs: 1 Width (mm): 412.5 Height (mm): 133 Thickness (mm): 27	
900652-01,2950562M91, 7395-780, 4124-497, 2950562M91	<u>73385</u> Bell, Euclid, Frisch Faun, Hanomag, Komatsu, Moxy, O and K	PAD105 Set Pcs: 1 Width (mm): 136.1 Height (mm): 104.1 Thickness (mm): 24	
WVA29083, 201807, 207459, 217187	<u>73386</u> Bell	Set Pcs: 1 Width (mm): 150.5 Height (mm): 114 Thickness (mm): 26	
385-10-178472, 385-10- 178473, 385-10-178474, 385- 10-178461, JCA1024	<u>73387</u> Komatsu	Set Pcs: 1 Width (mm): 319.4 Height (mm): 98.3 Thickness (mm): 22	





Offroad Brake Pads

	Part No & Application	Information	Image Reference
WVA29324, 4209220, 14208820, 14209020, 15866042, 24201320, 24202920, A0004209220, A0014208820, A0014209020, A0015866042, A0024201320	73390 UNIMOG	Set Pcs: 1 Width (mm): 149.8 Height (mm): 82.4 Thickness (mm): 20	
2415U136S5	73391 CNH Industrial	Set Pcs: 1 Width (mm): 219.7 Height (mm): 83.3 Thickness (mm): 22	
YY26184020	73396 Kawasaki	Set Pcs: 1 Width (mm): 220 Height (mm): 112 Thickness (mm): 23.5	
11992515, 15234854, 561-34-61110, 261-34-61110, 5054397, 15501589, 11992513	73398 Bell, Faunfrisch, Hanomag, Ljungby Maskin, Terex, Volvo	Set Pcs: 1 Width (mm): 261 Height (mm): 82 Thickness (mm): 21.6	
E110393, E131950	73399 Case	Set Pcs: 1 Width (mm): 116 Height (mm): 73 Thickness (mm): 19	
41B-33-11510, 41B-33-05030, 567-32-05111, 567-32-05110, 41B3311510, 41B3305030, 5673205111, 5673205110	73411 Komatsu	Set Pcs: 1 Width (mm): 292.2 Height (mm): 105.8 Thickness (mm): 22.5	
477/01006, 15/920118, 15/920395, 454/04401, 15/920118B, 15/920395B, 15/920119, SX016799SP, 79049871, 79111708, 79085961	73420 JCB, Fiat	PAD107 Set Pcs: 1 Width (mm): 117.2 Height (mm): 82.5 Thickness (mm): 19	
E11102360	73427 GMC, Ford, International	Set Pcs: 1 Width (mm): 229 Height (mm): 103 Thickness (mm): 25.4	
4v8416, 9C8021, 4E9703, AK1551, 4V8417, 9C8022, 4E9704, AK1552	73430 Caterpillar, Komatsu, Dresser	Set Pcs: 1 Width (mm): 323.8 Height (mm): 100.5 Thickness (mm): 25.4	

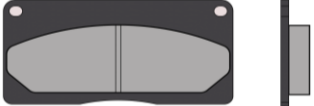
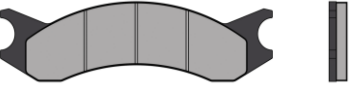
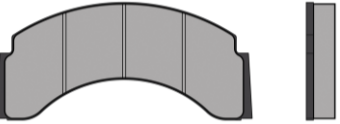
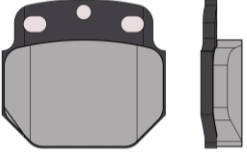
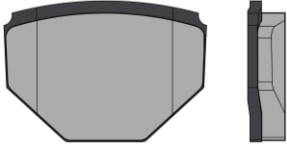
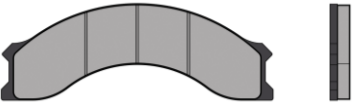

Offroad Brake Pads

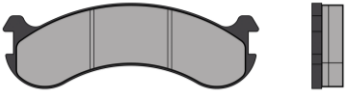
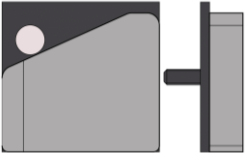
	Part No & Application	Information	Image Reference
20G-32-21211, 20G-32-21641, 22T-22-13651	73435 Komatsu	Set Pcs: 1 Width (mm): 180 Height (mm): 91 Thickness (mm): 22	
36354.300.200, 36354300200	73576 Kato	Set Pcs: 1 Width (mm): 320 Height (mm): 84.8 Thickness (mm): 20	
4063205, AK1534, 912621, 914715, VE3909, VE1790, 225502, 802704929, 1343137, A3222T1944, 244-7831	73791 Euclid, Komatsu, Unit Rig, Dresser, RayGo, Kalmar, Hyster, Meritor	Set Pcs: 1 Width (mm): 321.9 Height (mm): 154 Thickness (mm): 36	
22351906	73800 Fantuzzi	Set Pcs: 1 Width (mm): 109 Height (mm): 98.5 Thickness (mm): 27.5	
11990436, 6630838, 11714581	73801 Volvo	Set Pcs: 1 Width (mm): 138.8 Height (mm): 96.3 Thickness (mm): 25.5	
SW454196, 15273421, 15051576, 11709020, LSP10141, 17410218, 11707778	73821 Aveling Barford, Terex, Volvo	Set Pcs: 1 Width (mm): 371 Height (mm): 130 Thickness (mm): 27	
4214305210, 4214315910, 421-43-05110	73823 Komatsu	Set Pcs: 1 Width (mm): 260 Height (mm): 86.5 Thickness (mm): 31.5	
11992515, 15234854, 561-34-61110, 5054397, 15501589, 220135, 8R9975, 328W751	73824 Volvo CE, Terex, Komatsu, Moxo, Bell, Caterpillar, Carlisle	PAD106 Set Pcs: 1 Width (mm): 260 Height (mm): 86.5 Thickness (mm): 31.5	
419-43-15910, 4120000087010, 4120000087044, 4120000087043	73825 Komatsu, SDLG	Set Pcs: 1 Width (mm): 51.7 Height (mm): 48.6 Thickness (mm): 14	





Offroad Brake Pads

	Part No & Application	Information	Image Reference
1149299, E12978447, E12975249, 12975248, 15266824, 7396-184, SW651500/311, 112768	<u>73826</u> Caterpillar, Euclid, Hitachi Construction Machinery, Hitachi, Terex, O and K, Aveling Barford, Astra	Set Pcs: 1 Width (mm): 442.8 Height (mm): 140.5 Thickness (mm): 25	
N/A	<u>73828</u>	Set Pcs: 1 Width (mm): 199.6 Height (mm): 68 Thickness (mm): 26	
N/A	<u>73835</u>	Set Pcs: 1 Width (mm): 142.6 Height (mm): 84.6 Thickness (mm): 21	
12968245, 15265398, 328-741, 8480288, 567-32-05120, RX454107, S301668, 60830032	<u>73837</u> Volvo CE, Terex, Carlisle, O and K, Komatsu, Aveling Barford, Case, Astra, JCB	Set Pcs: 1 Width (mm): 320.1 Height (mm): 107.7 Thickness (mm): 27	
N/A	<u>73848</u>	Set Pcs: 1 Width (mm): Ø75 Height (mm): Ø63 Thickness (mm): 14	
20-060-008	<u>73851</u> Mico	Set Pcs: 1 Width (mm): 160 Height (mm): 89 Thickness (mm): 18	
N/A	<u>73852</u>	Set Pcs: 1 Width (mm): 204.6 Height (mm): 120 Thickness (mm): 24	
E30632, 6231875, 79121109	<u>73862</u> Case, Volvo CE	Set Pcs: 1 Width (mm): 104.2 Height (mm): 77.1 Thickness (mm): 21	
N/A	<u>73864</u>	Set Pcs: 1 Width (mm): 164.8 Height (mm): 88.5 Thickness (mm): 21	



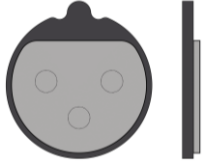

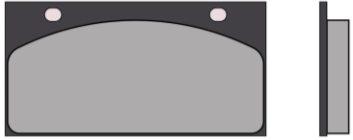
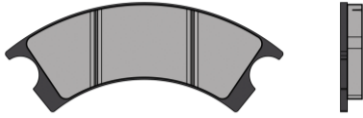
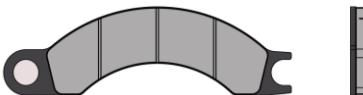

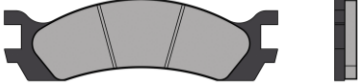
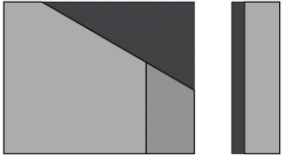

Offroad Brake Pads

Cross Reference	Part No & Application	Information	Image Reference
ABP3005170, 159-1151P, 15/920103, 2908254, 1594-1151P, 15/920087, F03/11309, 8603631	<u>73875</u> Aveling Barford, Benford, JCB, Volvo CE, Terex, THWAITES, HIDROMEK, CNH Industrial, Volvo, Case	Set Pcs: 1 External Diameter (mm): Ø66.5 Height (mm): 71.5 Thickness (mm): 8	
N/A	<u>73876</u>	Set Pcs: 1 External Diameter (mm): 62.4 Height (mm): 52 Thickness (mm): 10	
T53800, 4203400, 505782, 53800, 564763, 9968927, 9969115, AZ57173, 2590128, T53799	<u>73881</u> Case, Caterpillar, Clark, John Deere, Komatsu, Manitou, Matbro, Terex, Thwaites	Set Pcs: 1 Width (mm): 110.5 Height (mm): 46 Thickness (mm): 11	
N/A	<u>73882</u>	Set Pcs: 1 Width (mm): 108.2 Height (mm): 65 Thickness (mm): 9.5	
36C0005, 408107108, 408107-108, 51A0201, 4120001739016, 3190009089	<u>73898</u> XGMA XIAGONG, SDLG	Set Pcs: 1 Width (mm): 215 Height (mm): 110 Thickness (mm): 24	
100347, 35C0025, S22-5694-1, ZL50C.2.2.2	<u>73899</u> LIUGONG	Set Pcs: 1 Width (mm): 282.2 Height (mm): 110.1 Thickness (mm): 22	
N/A	<u>73910</u>	Set Pcs: 2 Width (mm): 144.3 Height (mm): 117.15 Thickness (mm): 21.6	
N/A	<u>73918</u>	Set Pcs: 2 Width (mm): 144.3 Height (mm): 104.5 Thickness (mm): 21.6	
1K.328.762, 008480510, 15265781, 15501588, MS-15501588	<u>74067</u> Fantuzzi, O and K, Terex	PAD160 Set Pcs: 1 Width (mm): 425 Height (mm): 128 Thickness (mm): 25	

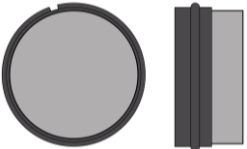

Offroad Brake Pads

	Part No & Application	Information	Image Reference
N/A	<u>74423</u>	Set Pcs: 1 Width (mm): 273.8 Height (mm): 82 Thickness (mm): 22	
993/23600, 993/12500, 15/920159	<u>76000</u> JCB	Set Pcs: 1 Width (mm): 47.5 Height (mm): 37.8 Thickness (mm): 11.5	
15/920159, ABP3002583, T1600, 041-00334, 45/412-29	<u>76001</u> JCB, Aveling Barford, Thwaites, Broderson	Set Pcs: 1 Width (mm): 85.7 Height (mm): 43 Thickness (mm): 17.8	
11992572, 6212867, 12182073	<u>76002</u> Volvo CE	Set Pcs: 1 Width (mm): 73.2 Height (mm): 53 Thickness (mm): 26	
11992564, 11992564-2, 68852800, 4912263M1, 11992564	<u>76003</u> Volvo CE, Hanomag, Demag, Komatsu, Bolinder Munktel, Schopf, Wabco	Set Pcs: 1 Width (mm): 91.2 Height (mm): 64.2 Thickness (mm): 33	
244-7852, 220746, 84252208, 333/E5760, 746005	<u>76004</u> Carlisle, Bell, Case, JCB, Manitou, Volvo CE, Liebherr GMBH, TUG, Schopf	Set Pcs: 1 Width (mm): 114.8 Height (mm): 99.75 Thickness (mm): 16	
N/A	<u>76005</u>	Set Pcs: 1 External Diameter (mm): Ø64.67 Thickness (mm): 11.1	
VE7632, VE6813, 2000N1470	<u>76813</u> Komatsu, Carlisle	Set Pcs: 1 External Diameter (mm): Ø53.47 Height (mm): 53.8 Thickness (mm): 10.6	
2029.1408, 0000805388, 1000019915	<u>80188</u> Gehl Construction, Kramer	Set Pcs: 1 External Diameter (mm): 42.1 Thickness (mm): 19.3 Thickness Of Friction Material (mm): 8.9	



Transaxle

Remanufactured Commercial
Brake Calipers

OE NUMBERS USED FOR REFERENCE ONLY

Scan Here To Access Our Product Catalogues Online



Parking Brakes

	Reference Number	Information	Image Reference
	TRX	<u>Volvo CE Parking Brake: Fits models - A25B, A25C Volvo BM & A35</u> Volvo: 11054758	



Transaxle

Remanufactured Commercial
Brake Calipers



Transaxle Ltd
Walstead Road West
Walsall, WS5 4NY
T: +44 1922 471300
F: +44 1922 725072
E: info@transaxle-ltd.co.uk